

Emotron FDU/VFX 2.0 Liquid Cooling



Instruction manual
English

Contents

1.	General information	3
1.1	Process and instrumentation	3
1.1.1	Circuit components.....	3
2.	Installation	4
2.1	Installation specifications.....	4
2.2	Connections.....	4
2.3	Fan	4
2.4	Flow conditions.....	4
2.5	Calculation examples.....	6
2.6	Condensation	7
3.	Maintenance of inverter	8
3.1	Check of the liquid	8
3.2	Maintenance schedule	8
4.	Mounting instructions.....	9
5.	Technical Specification.....	12
6.	Specification drinking water quality.....	13

1. General information

1.1 Process and instrumentation

As factory mounted option it is possible to cool the variable speed drive (VSD) with liquid. The liquid circulation of the inverter is usually connected to an external heat-exchanger (liquid – liquid / liquid - air). The heat exchanger is not part

of the Liquid Cooling option. Contact your supplier for further information.

1.1.1 Circuit components

Figure 1 will show a simplified example of an open-loop cooling system.

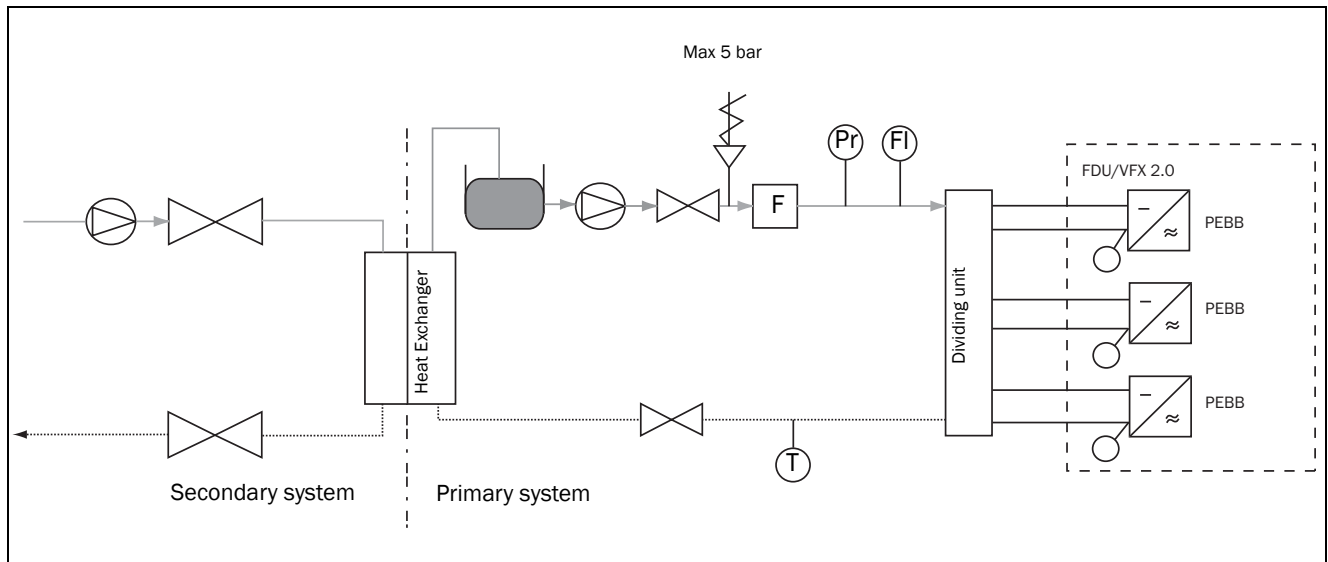



Fig. 1 Example open-loop system

Table 1

F	Filter
FI	Flow Indicator
Pr	Pressure Indicator
T	Temperature indicator
	Pump
	Valve
PEBB	Power Electronic Building Block

The liquid temperature is indirectly controlled with an internal temperature circuit of the VSD. This will switch of the VSD if the internal temperature becomes too high.

2. Installation

2.1 Installation specifications

The cooling materials are made of aluminium, galvanic copper, stainless steel and Ethylene Propylene Diene Monomer (EPDM) rubber, the cooling medium allowed to be used are:

- a mix of water and glycol
- demineralised water
- or drinking water (see Chapter 6. page 13).

The liquid should not contain organic sediment or chemically active qualities. When adding a liquid to the system it is recommended that a filter is used so that no particles larger than 0.1 mm can enter the circuit. The minimum specifications of the quality of the used drinking water can be found in Chapter 4. page 9.

At low temperatures the system needs to be protected against freezing. A mixture of glycol (minimal 20%) and water can help against freezing. Consult your supplier for the best protection.

To avoid electrolytic corrosion, we furthermore recommend adding an inhibitor for all allowed cooling mediums. See chapter Technical Specification for more information.

2.2 Connections

To minimize the pressure drops of the liquid it is advised to make the piping's as straight as possible. To prevent dirt particles stick in the piping and connections and thus decreasing the cooling effect, it is recommended to install a suitable filter.

Prior to the actual connection of the pipes, the pipes shall be cleaned thoroughly. Advisable is to clean this with water, if this is not possible do this with pressured air.

When using wall mounted IP54 (size E or F) VSD the external cooling system can directly be coupled to the VSD.

When a VSD is used with multiple PEBBs (size G and up) it is advised to use our dividing unit, which is part of the option. This unit shares the flow equally to the connected PEBBs. For all the connected PEBBs the fittings must be identical to guarantee equal flow sharing. To easily disconnect the system, manual valves are advised at the in- and output of the dividing unit, furthermore pressure, flow and temperature indicators are advised.

The intended position of the dividing unit is on top of the cabinet. See Chapter 4. page 9 for more details.

The variable speed drives are equipped with rubber hoses. Passing the hoses through the top of the cabinet can be realised by guiding them through IP54 glands. The hoses are implemented with drip-free quick couplers. These couplers allow easy disconnecting the hoses without spilling fluid.

To minimize the risk of galvanic corrosion it is advised to use stainless steel, the same material as the divider unit, for the fittings and piping's.

If stainless steel is not used the following main line hoses are allowed.

- Plastic (PVC)
- Rubber (EPDM only)
- Copper (un-isolated contact with stainless steel should be avoided)
- Other stainless and acid proof materials

2.3 Fan

Some heat producing components are not thermally coupled with the liquid cooled heat sink. The internal cooling fan of the drive cools these components and is factory set to a pre-defined speed, in order to ensure sufficient cooling.

Typically 2% of the used energy is power losses. Most of these power losses are dissipated in the liquid and removed from the cabinet. For the remaining losses, sufficient measures have to be taken to keep the internal cabinet temperature $\leq 40^{\circ}\text{C}$. Furthermore the ambient temperature outside the cabinet has to be $\leq 40^{\circ}\text{C}$.

2.4 Flow conditions

To guarantee sufficient cooling we advise to use a flow of approximately 7 l/min per PEBB. The Size E and F inverters will have this flow at approximately 1.8 bar (100% drinking water), more details for size G and up can be derived according to calculation on next page.

The specific heat capacity of an ethylene glycol based water solution is less than the specific heat of pure water. For a heat transfer system the circulated volume must

be increased. When using 30% ethylene glycol the heat capacity of this mixture can decrease with 20%.

The increased pressure drop due to the higher viscosity of ethylene glycol compared to water needs also to be compensated for. The combined compensation needed for the decreased specific heat and the pressure drop increase can go up to 100% for a 30% mixture. The system pressure to reach the specified flow is influenced by a lot of variables.

The liquid temperature leaving the VSD should not exceed 65°C .

With the following equations you can derive the pressure and/or flow.

The equations can be used to calculate required flow, resulting pressure and are valid for 100% water. Note that using a water glycol mixture will result in a fluid with a lower specific heat and a higher viscosity. These properties will degrade cooling behaviour. Emotron can provide non binding data to calculate with different glycol-water mixture percentages.

$$\text{Flow}(\delta T, n_{\text{PEBB}}) = n_{\text{PEBB}} \times \frac{30}{\delta T} \text{ [l/min]}$$

$$\text{Pressure}(\text{Flow}) = 0.0484 \left(\frac{\text{Flow}}{n_{\text{PEBB}}} \right)^{1.863} \text{ [bar]}$$

Where:

Flow = Liquid flowing through the system (l/min)

n_{PEBBs} = Amount of connected PEBBs

δT = Difference between in and outlet temperature.

Pressure = The pressure of the total system on the in and outlet (bar)

Examples on calculating flow and pressure for the VSD cooling part of the system can be found in chapter 2.5 Calculation examples, page 6

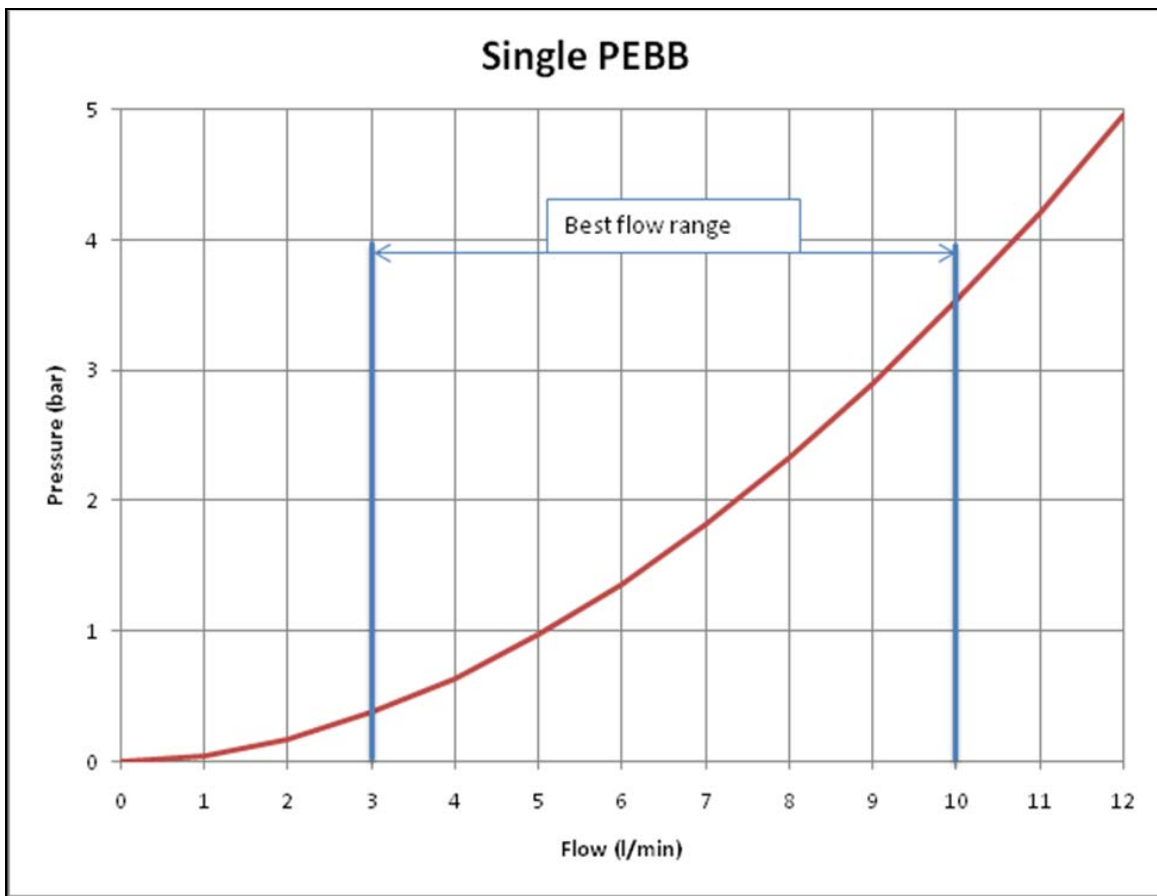

Fig. 2 Overview frequency inverter

Table 2 Number of PEBB's for each fram size - 480 V

Amp	Frame size 480 V	Number of PEBB
146-175	E	1
210-250	F	1
300-375	G	2
430-500	H	2
600-750	I	3
860-1000	J	4
1200-1500	K	6

Table 3 Number of PEBB's for each fram size - 690 V

Amp	Frame size 690 V	Number of PEBB
90-175	F69	1
210-375	H69	2
430-500	I69	3
600-650	J69	4
750-1000	K 69	6

2.5 Calculation examples

In the following examples we would like to explain how it is possible to work with the equations and figure in Fig. 2, page 5

1st Example

One PEBB, VFX/FDU 48-090 correct system

Known values

Inlet Temperature	T = 45 °C
Desired delta T	δT = 5 °C
Type of inverter	FDU/VFX 48-090

Using following equations

$$\text{Flow} = 1 \times \frac{30}{5} = 6 \text{ l/min}$$

$$\text{Pressure} = 0.0484 \left(\frac{6}{1} \right)^{1.863} = 1.4 \text{ bar}$$

Gives the following summary

Flow_{tot} = 6,0 l/min
P_{tot} = 1.4 bar
T_{out} = 50.0 °C (T_{out} = T + δT)

A single PEBB (Power Electronic Building Block) is used. The flow is within the best range (3-10 l/min). The total pressure is within the limit the maximum system pressure of 5 bar. The Outlet temperature is below the maximum of 65°C. The system can be used.

2nd Example

3 PEBB's, VFX/FDU 48-600 incorrect system

Known values

Inlet Temperature	T = 50 °C
Desired delta T	δT = 16 °C
Type of inverter	FDU/VFX 48-600

Using following equations

$$\text{Flow} = 3 \times \frac{30}{16} = 5.6 \text{ l/min}$$

$$\text{Pressure} = 0.0484 \left(\frac{5.6}{3} \right)^{1.863} = 0.2 \text{ bar}$$

Gives the following summary

Flow_{tot} = 5.6 l/min
P_{tot} = 0.2 bar
T_{out} = 66.0 °C

Here are 3 PEBB's used so the total flow has to be divided by 3.

The flow is within the best range for a single PEBB (3-10 l/min).

The total pressure is within the limit the maximum system pressure of 5 bar.

The Outlet temperature is above the maximum of 65°C.

The system can NOT be used.

Change inlet temperature or change desired δT.

Also it is advised to increase the total flow. By decreasing the δT the flow will increase.

3rd Example

3 PEBB's, VFX/FDU 48-600 correct system

Known values

Inlet Temperature	T = 30 °C
Desired flow	Flow = 21 l/min
Type of inverter	FDU/VFX 48-600

Using following equations

$$\text{Flow} = 3 \times \frac{30}{\delta T} \quad \text{l/min}$$

gives flow formula to solve δT

$$\delta T = \frac{30 \times 3}{21} = 4,3 \text{ °C}$$

$$\text{Pressure} = 0.0484 \times \left(\frac{21}{3}\right)^{1.863} = 1.8 \text{ bar}$$

Gives the following summary

Needed $\delta T = 4.3 \text{ °C}$
$P_{\text{tot}} = 1.8 \text{ bar}$
$T_{\text{out}} = 34.3 \text{ °C}$

Here are 3 PEBB's used so the total flow has to be divided by 3.

The total pressure is within the limit the maximum system pressure of 5 bar.

The Outlet temperature is below the maximum of 65°C

The system can be used.

2.6 Condensation

To avoid condensation, the temperature of the liquid must be held higher than the ambient temperature of the electrical room where the VSD is positioned. If these conditions are not met, take actions by decreasing the room temperature and/or the relative humidity or increase the cooling liquid temperature.

Note that with increasing the cooling liquid temperature, this can decrease the performance of the VSD.

3. Maintenance of inverter

3.1 Check of the liquid

In time the liquid can get contaminated by floating particles from the system. This will decrease the conductivity. When the conductivity of the liquid decreases, the risk of electrochemical reactions between the different alloys, in the primary system, increases. The contamination for a closed system is less than for an open system.

For both open- and closed systems inhibitors are advised. Checking the liquid is an important part of the maintenance. See Chapter 3.2 page 8

3.2 Maintenance schedule

There are a few systematic maintenance tasks that have to be followed to ensure an optimal operation of the liquid cooling unit. They are presented in the Table 4.

Table 4 Maintenance schedule

	Every 6 months	Once a year
Checking quick couplers		√
Checking filter		√
Inspection	√	√

The 6 monthly inspections include the followings tasks:

- Check the system for possible leaks. It is dangerous to use the VSD while leaking.
- This check has only to be done for a closed system. Check the pressure of the system for abnormal variations. Rising pressure can indicate flow obstruction.
- Check the flow in the primary circuit at flow indicator. The flow must be minimal as initial setup.
- Check the heatsink temperature in menu [71A]. A higher value as normal can indicate cooling problems. The nominal value shall not exceed 70°C.
- Check the quick couplings for leakage. Please report abnormalities to Emotron.

The 1 year inspection includes the following tasks:

- Disconnect the quick couplers and check for visible residue. Please report abnormalities to Emotron.
- Check the filters for leakage or other visible residue.
- The checklist from the 6 monthly inspections.

4. Mounting instructions

The dividing unit has to be placed on top of the cabinet, see Fig. 3 to Fig. 7 at what position the dividing unit has to be placed and where the holes have to be drilled.

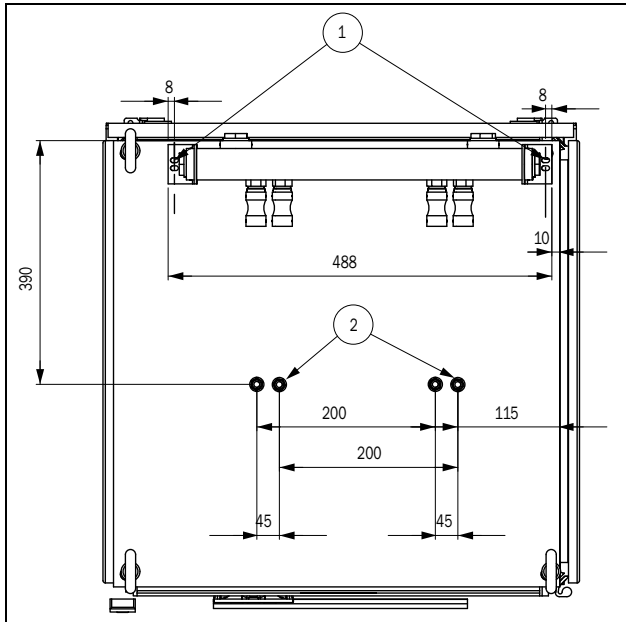

Fig. 3 Top view dividing unit for frame size H(69)

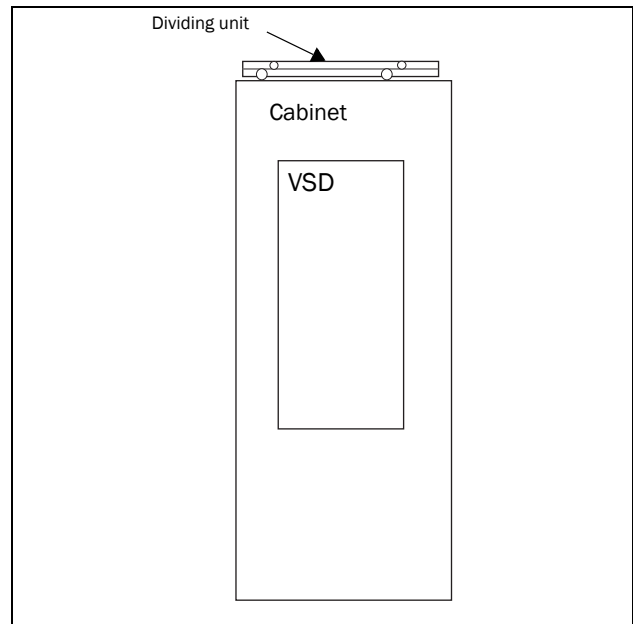

Fig. 4 Front view

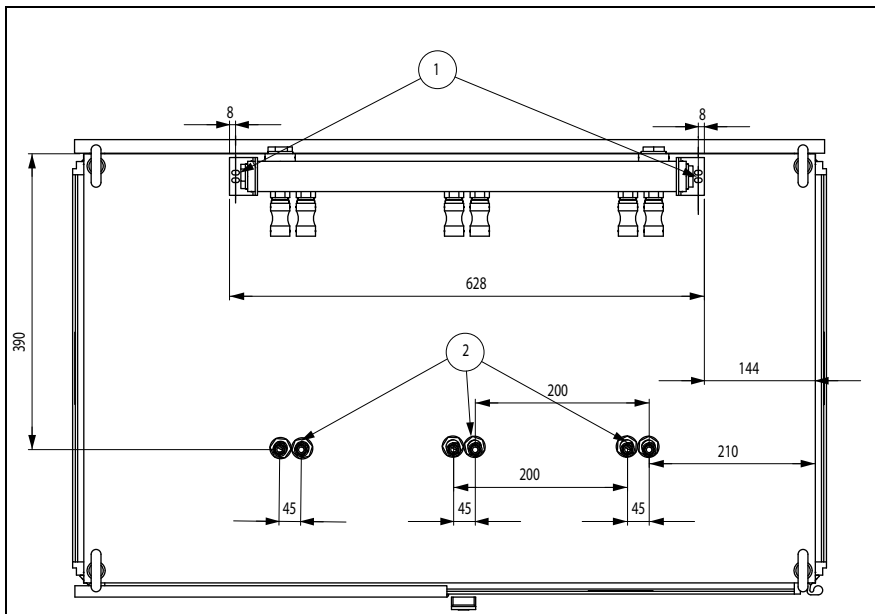

Fig. 5 Overview dividing unit for frame size I(69)

NOTE:

1. Dividing unit can be mounted with 4 bolts M5x30 on top of the cabinet

2. 4 holes for size H (69) or 6 holes for size I (69) gland M40x1,5, the glands will guide the hoses through the roof of the cabinet

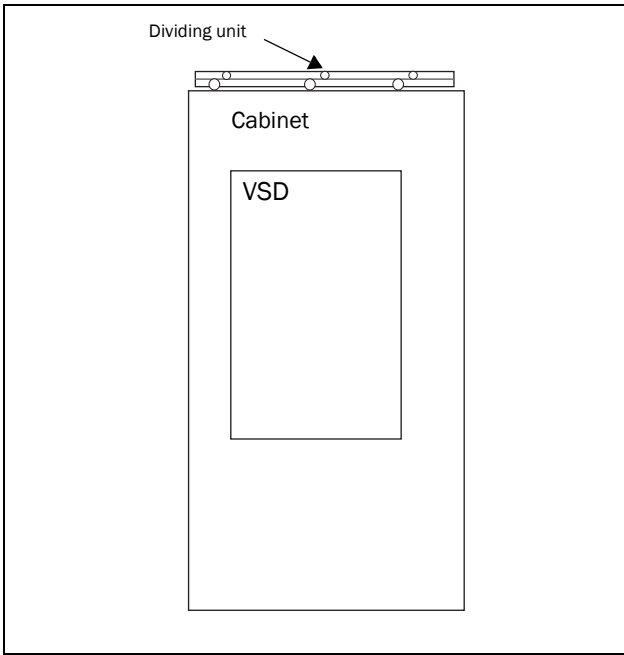

Fig. 6 Front view

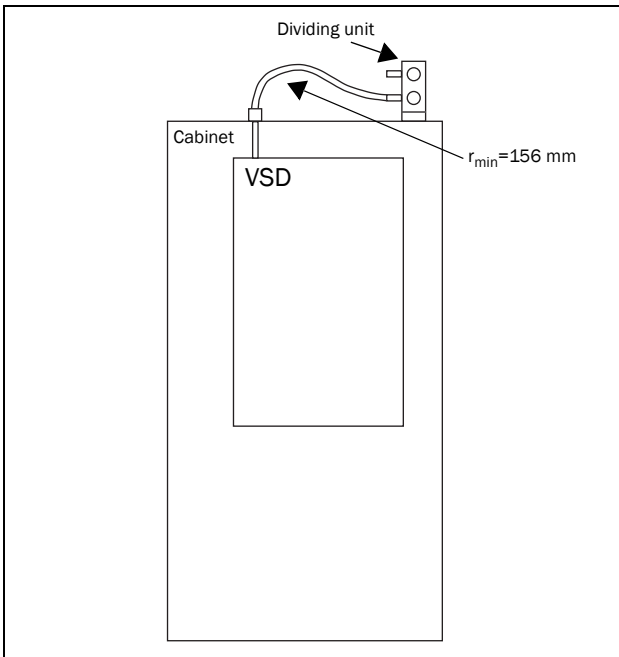

Fig. 7 Side view of cabinets

When two or more dividing units are part of the system, Emotron advises to place them in parallel to minimize pressure drops of the system. Position the parallel connection as close as possible to the cabinet; this to minimize flow differences in the system.

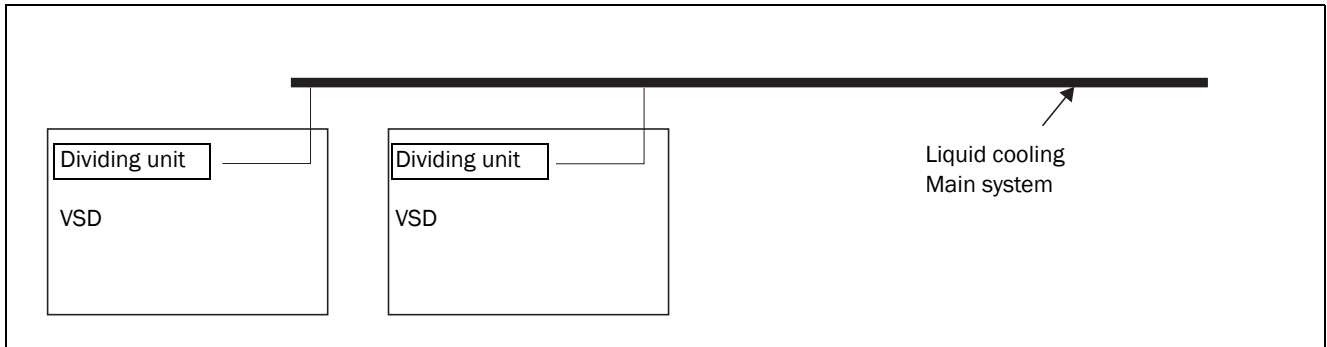

Fig. 8 Top view parallel connection with two dividing units

The length of the hoses restricts the position of the VSD within the cabinet. By putting the VSD as high as possible in the cabinet the easier it is to connect the hoses (If necessary with a curl) to the dividing unit.

The hoses coming from the VSD should be connected as shown in Fig. 9. Hose with the white arrow in red box has to be connected to the red box with OUT written in it.

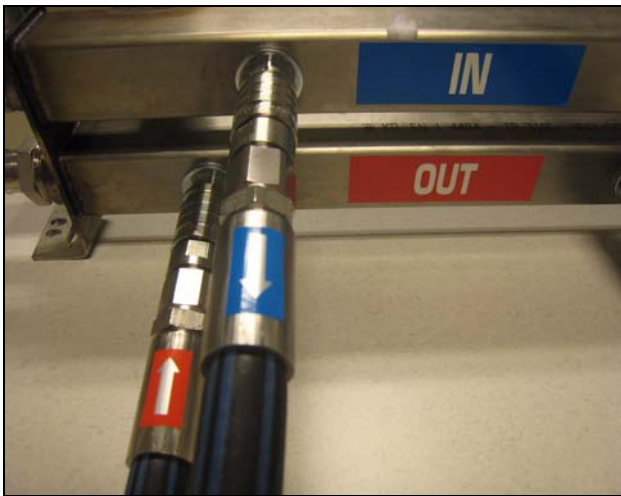

Fig. 9 Front view dividing unit and hoses

Always take care that the constraints of the liquid cooling system are kept, see chapter 5. and 6.

5. Technical Specification

Main liquid connections dividing unit:

- BSPT(British Standard Tapered Pipe) thread 1”
- Female quick coupling outer thread 3/8” (see note)

Ambient conditions:

- Temp: +0 – +40°C
- RH: 5–90%, no condensation allowed

Pressure ratings primary circuit:

- max. working pressure 5 bar
- max. peak pressure 7 bar.

Temperature ratings cooling liquid:

- max. outlet temperature 65 °C
- Input temperature must be higher as ambient temperature to prevent condensation

Required flow of liquid Cooling

- Approximately 7 l/min per PEBB
- Range 3 – 10 l/min per PEBB

Amount of liquid in system and pressure drop based on 100% drinking water.

Table 5 *Liquid and pressure drop*

Frame size	Volume (litre)	Pressure drop
E	1	Depending on flow. Examples are given in application notes
F(69)	1.1	
G(69)	3.1	
H(69)	3.3	
I(69)	4.6	
J(69)	6.6	
K(69)	9.2	

Anti corrosion inhibitor

- Open-loop system
Cortec VpCI-647
Ferrofos 8500
- Closed-loop system
Cortec VpCI-649
Ferrolix 335
- Mixture water/inhibitor: depending on the mixture glycol/water and type of system (open / closed), advice is to check supplier of inhibitor for the exact values.

Antifreeze protection

- Antifrogen with an active substance glycol; e.g. available from Clariant (www.clariant.com)
- Mixture water/antifreeze: depending on the mixture glycol/water, type of inhibitor and type of system (open / closed), advice is to check supplier of glycol for the exact values.

NOTE: Applies only when size E or F inverter is delivered.

6. Specification drinking water quality

Table 6 Specification water quality

Quality	Unit	Value
pH		6...8
Hardness of liquid	°dH	3...8
Free carbon dioxide	mg/dm ³	8...15
Associated carbon dioxide	mg/dm ³	8...16
Aggressive carbon dioxide	mg/dm ³	0
Sulphides free		free
Oxygen	mg/dm ³	<10
Chlorides ions	ppm	<40
Sulphate ions	ppm	<50
Nitrates and nitrites	mg/dm ³	<10
COD	mg/dm ³	<7
Ammonia	mg/dm ³	<5
Iron, Fe	mg/dm ³	0.2
Manganese	mg/dm ³	0.2
Conductivity	µS/cm	<400
Solid residue from evaporation	mg/dm ³	<500
Potassium permanganate consumption	mg/dm ³	<25
Suspended matter	mg/dm ³	<3
Maximum particle size	µm	<100
Dissolved substances	ppm	<340



DEDICATED DRIVE

Emotron AB, Mörsaregatan 12, SE-250 24 Helsingborg, Sweden

Tel: +46 42 16 99 00, Fax: +46 42 16 99 49

E-mail: info@emotron.se

Internet: www.emotron.com